The CED Power1401-3A Owners Handbook

Copyright © Cambridge Electronic Design Limited 2016

Neither the whole nor any part of the information contained in, or the product described in, this guide may be adapted or reproduced in any material form except with the prior written approval of Cambridge Electronic Design Limited.

1st edition (1.1)

August 2016

Published by:

Cambridge Electronic Design Limited
Science Park
Milton Road
Cambridge
CB4 0FE
UK

Telephone:	+44 (0)1223 420186
USA & Canada Toll Free:	1-800-345-7794
Fax:	+44 (0)1223 420488
Web:	www.ced.co.uk
Email:	info@ced.co.uk

Trademarks and Tradenames used in this guide are acknowledged to be the Trademarks and Tradenames of their respective Companies and Corporations.

Table of contents

Preface	Publishing information.....	i
	Table of contents.....	ii
	Typographic conventions.....	iv
	Use of symbols.....	iv
	Potential for Radio/Television interference.....	v
	Power1401-3A upgrades.....	vi
	Life support.....	vi
Getting started with the Power1401-3	Fast installation guide.....	1
	Introduction.....	2
	Confidence check.....	3
	Installing the Power1401-3.....	4
	Storage and operating environment.....	4
	Application software.....	5
Installing the USB interface	Overview.....	6
	Software installation.....	6
	Hardware installation.....	6
Test software	Installing test & diagnostics.....	9
	Windows diagnostics.....	10
Application software: Spike2 & Signal	Running the Power1401 with Spike2.....	12
	Running the Power1401 with Signal.....	13
Inputs and outputs	General.....	14
	Waveform input.....	15
	Waveform output.....	17
	The rear-panel analogue connector.....	18
	Clocks.....	20
	Frequency synthesizer.....	21
	Event inputs.....	22
	Digital input and output.....	23
	USB port.....	27
	Synchronization port.....	27
	RS232.....	28
	DC power inlet.....	28

Hardware expansion	The ADC16 top-box: 16 waveform inputs.....	29
	The PGA16 top-box: 16 programmable-gain ADC inputs	30
	The Signal top-box: 4 extra DACs.....	31
	The Spike2 top-box: digital BNC connections	32
Mechanics of the Power1401-3A	Construction	33
	Earthing	34
	Upgrade by users	34
Maintenance operations	Introduction	35
	Taking the lid off.....	35
	Switch settings.....	35
	I/O components	36
	Internal connectors & other features	37
	Memory upgrades.....	38
	Setting the ADC input range	39
	Flash ROM	40
	Analogue calibration	41
Cleaning the Power1401	42	
Trouble shooting	Overview	43
	Stand-alone test	43
	LED diagnostic patterns	44
	Calling the CED Help Desk	45
Index	Index	1
	User notes	1
Specification	Specification.....	50
	EC declaration of conformity	51

General information

Typographic conventions The following conventions apply to the text in this manual:

- Ordinary text is in Times New Roman
- Titles of chapters, other manuals and other publications, including CDs, are in *Times New Roman italics*
- Labels and identifiers appearing on the equipment described in this manual are in Arial
- Menu items, buttons, and other contents of computer displays are in *Arial italics*
- Names of files, drives, paths and directories are in Courier New
- Signal names are in Times New Roman, SMALL CAPS

Use of symbols Where applied, the following symbols have the meanings below:



This symbol declares that the equipment passes the relevant clauses of EU directives on safety and EMC emissions. See the certificate reproduced on page 51



Observe precautions against electrostatic discharge



The CED Power1401-3A is lead-free and conforms to the EU RoHS directive



The CED Power1401-3A is subject to the EU WEEE regulations and may be returned to CED Ltd for recycling



Attention, consult accompanying documents



The DC symbol indicates that the Power1401-3A chassis is powered from a DC-only supply



The earth symbol indicates a metallic contact at mains earth potential

**Potential for
Radio/Television
Interference**
(USA only)

The Power1401-3A generates and uses radio frequency energy and may cause interference to radio and television reception. Your Power1401-3A complies with the Specification in Subpart J of Part 15 of the Federal Communications rules for a Class A computing device. These specifications provide reasonable protection against such interference in a residential installation. However there is no guarantee that interference will not occur in a particular installation. If the Power1401-3A does cause interference to radio or television reception, which can be determined by turning the Power1401-3A mains supply off and on, you can try to eliminate the interference problem by doing one or more of the following:

- Re-orient the receiving antenna
- Re-orient the position of the Power1401-3A with respect to the receiver
- Move the Power1401-3A away from the receiver
- Plug the Power1401-3A into a different outlet so that the Power1401-3A and the receiver are on different branch circuits

If necessary, consult CED or an experienced radio/television technician for additional suggestions. You may find the booklet, prepared by the Federal Communications Commission, helpful: *How to Identify and Resolve Radio/TV Interference Problems*. The booklet is available from the US Government Printing Office, Washington DC 20402, Stock no. 004-000-00345-4.

To comply with FCC rules, Part 15 B Class A Computing device, use only shielded interface cables.

Power1401-3A upgrades The Power1401-3A is the evolutionary successor to the Power1401 II and the Power1401-3. Upgrades include:

- From Power1401 II**
- Completely redesigned computational core using the Marvell 78100 microprocessor, with provision for dual-core operation using the Marvell 78200 microprocessor
 - Processor clock rate increased from 800 MHz to 1 GHz; bus clock rate increased from 66 MHz to 200 MHz
 - Maximum internal memory increased from 1 GByte to 2 GByte of DDR RAM; DDR RAM clock rate increased from 200 MHz to 400 MHz
 - USB2 port integral to processor permitting a significantly faster data transfer rate (from 27 MByte/sec to 47 MByte/sec to host; from 10 MByte/sec to 45 MByte/sec to Power1401)
 - New de-glitched DAC: 1.5 nV.s maximum glitch energy
 - DAC offset & gain calibration by software
- From Power1401-3**
- FPGA upgraded from XC6LSX45 (43,661 equivalent logic cells) to XC7K70T-2-FBG484C (65,690 equivalent logic cells)
 - Flash memory implemented as 16 Mbyte SPI NOR flash with main & backup devices
 - New 18-bit, 5 Msample.sec⁻¹ ADC eliminates analogue trimming & simplifies recalibration (user still sees 16 bits)

Life support CED products are not authorized for use as critical components in life support systems without the express written approval of the chairman of the board of directors of CED.

Life support systems in this context are systems which support or sustain life, and whose failure to perform, when properly used in accordance with instructions for use provided, can be reasonably expected to result in a significant injury to the user. A critical component in this context is any component of a life support system whose failure to perform can reasonably be expected to cause the failure of the life support system, or to affect its safety or effectiveness.

Fast installation guide

Step 1 Install the software first: either your CED application or the CED 1401 installation CD. CED software currently runs on the 32-bit or 64-bit version of Windows XP or later. If you have an earlier version of Windows, it will need to be upgraded

Step 2 Set up your hardware:

- Power-up the computer and the Power1401
- Connect the USB data cable. The cable supplied, labelled 'CED', is shielded and guaranteed for full-speed data transfer. Off-the-shelf items MAY WELL NOT WORK
- USB hardware is recognized and correct driver located automatically. On some versions of Windows, the device driver has to be approved by the user, which requires various *OK* boxes to be clicked

For details, see page 6

Step 3 Check the installation:

- Run the TRY1401 utility installed with your CED software. Click on *All On* to select all tests, click on *Run Once* to run the tests
- Running the tests should take only a few seconds and give no errors

Step 4 Your Power1401 is now ready for use

Getting started with the Power1401-3A



Introduction This manual will guide you through the initial check and installation of your Power1401-3A. It introduces you to the external inputs and outputs, and expansion options. It also describes maintenance and diagnostic procedures. Hereafter, your machine is referred-to as the Power1401 except where it differs from the previous model. ‘1401’ used by itself refers to the 1401 family generically. This manual does not cover 1401 programming or the use of application programs with the Power1401.

Windows version Examples of screen dumps and user dialog are mostly taken from Windows 7, with one or two from Windows XP and Windows 10. Details will differ slightly in other versions of Windows, but the operations are all very straightforward and users should not experience any difficulty.

Checklist The installation kit for your Power1401 comprises:

- A Power1401, with optional rack-mount kit
- A power brick with attached DC supply cable
- A mains cable for the power-brick suitable for your country
- A USB data cable: this is a high-quality, shielded item
- An installation disk
- This manual



The power brick The power brick will run without adjustment on any mains voltage from 100 V to 240 V, 47 Hz - 63 Hz, drawing a maximum of 1.6 A. It has no switch, being controlled simply by plugging in and switching on at the mains socket. A green LED indicates when the brick is powered up.

The front-panel push-switch actuates a relay inside the Power1401 that switches DC power to the rest of the circuitry. For complete electrical isolation, mains power must be disconnected from the power brick.



The power brick:
PowerSolve PSE60-312 shown

Confidence check Your Power1401 was soak-tested at CED before shipping. To pass the test, a Power1401 must not generate a single error in at least 96 hours of testing. The next procedure checks that the Power1401 hardware is in the same state as it left the factory.



Ensure that the front-panel DC switch, marked , is off, with the button protruding from the panel. Insert the power-brick output plug into the DC Power In socket. Check that the Mode selector is in position 1. *Do not* connect the USB cable. Switch the Power1401 on. The switch button should light red, while the yellow LEDs flicker. The button should then turn green, while the yellow LEDs continue to flicker. You can now connect the USB cable. If the button flashes red and green, turn to *Trouble shooting* on page 43.

Installing the Power1401 Once the Power1401 has passed the confidence check, you should turn to the section which deals with installation for your computer, starting on page 6. The remainder of this section deals with general topics. The section starting on page 14 describes the signal inputs and outputs. Following sections deal with expansion options, maintenance and troubleshooting.

Storage and operating environment The Power1401-3A must be kept in the temperature range of -5° to $+50^{\circ}$ Celsius, at a humidity of less than 95% saturation, non-condensing. The Power1401 is suitable for continuous operation. The Power1401 is not protected against ingress of water or dust. There are no hazardous voltages inside the Power1401. The Power1401 complies with relevant EU and USA requirements for electromagnetic interference. The Power1401 can be recycled: please contact CED for further details.



Position When choosing a permanent position for your Power1401, note that it prefers the same sort of environment as suits the host computer. The Power1401 normally stands on its base, but it will work on its side or upside down, if required.

The fan The Power1401-3A is equipped with a small fan, to expel the heat generated by the microprocessor and FPGA. This runs as necessary, venting to the rear. Be careful not to obstruct it. There should be a clear space at least 150 mm behind the case.

Over-temperature state If the fan should fail or be obstructed, a temperature sensor inside the Power1401 will shut off power to the microprocessor. The over-temperature condition is indicated by the LED in the power switch turning off, and the eight ADC LEDs and two DAC LEDs all turning on. If caused by an obstruction, removing it and switching the Power1401 off and on again should restore normal operation.



Over-temperature display: note power LED is off

- Application software** The Power1401 requires application software to run it. Most customers will run CED application programs for the Power1401, such as Signal or Spike2 (see pages 12 and 13), or products supplied by third parties. Alternatively, you may wish to write your own programs, with the help of the *1401 Language support* library (downloadable free of charge from the CED Web site: www.ced.co.uk), and your own computer programming manuals.
- Operating platforms** We support the 1401 family (including the Power1401-3A) under Windows XP (service pack 3), Vista, Windows 7, Windows 8, and Windows 10.
- Installing CED application software** CED application software such as Spike2 or Signal is installed from a CD. The installation program loads the 1401 drivers at the same time. The installation guide with the software will give more detailed instructions.
- Information on application programs** Technical information required to use CED application programs is contained in the software manuals. Technical histories of some of our programs, upgrade information, and in many cases downloadable files, may be found on www.ced.co.uk.
- Information for programmers** The 1401 language support kit, for users who wish to program their Power1401 from their host computer, includes the *1401 family programming manual* for detailed descriptions of the 1401 standard command library. The Power1401 command development kit includes the *Power1401 technical manual*, which documents the internal structure of the Power1401, and *Writing commands for the Power1401* which deals with writing commands in C to run on the Power1401's processor. Use of this kit is only recommended for program developers that are very experienced in writing embedded software.
- Circuit diagrams** Circuit diagrams for the Power1401-3A can be made available for a fee. Purchasers must sign a non-disclosure agreement. Note that the contents of programmable components (e.g. the SPI flash ROM and the FPGA) are *not* available.

Installing the USB interface

Overview This section describes how to install a Power1401-3A on a Windows PC, communicating via a USB port.

To install the Power1401 you will need:

- A Power1401
- A power brick and mains cable
- The USB data cable supplied by CED
- The CED software application disk

When installing the PC USB interface, the software is installed first, after which the hardware connection is made between the Power1401 and the computer. Installation follows the same procedure for all Windows operating systems.

Software installation The minimum software needed to control a Power1401 is the standard 1401 command library and the USB device drivers. These are supplied on the *CED 1401 installation software* disk, together with test and diagnostic utilities. To install the software, simply insert the CD. Typically it will autorun. If it does not, run *setup.exe*.

Installations with application software If you are installing Spike2 or Signal, the drivers, command library and test utilities are loaded at the same time as the application.

Hardware installation A Power1401 using the USB interface requires a computer with a USB2 port and connector. All you have to do is connect the USB data cable between the computer and the Power1401.

- The USB cable must be a high-quality product, shielded and rated for full speed, such as the one supplied by CED

Hot plugging USB hardware is designed for ‘hot plugging’. With the software installed, and both computer and Power1401 switched on, connect the USB cable. This causes the computer’s USB hardware to recognize the appearance of a new USB device. A message window will briefly announce that Windows has detected a new USB device and is looking for its driver. Since this has already been installed, it will report that it has found the CED 1401 USB software, and disappear.

**Device Manager,
view devices by type
(Windows 7)**

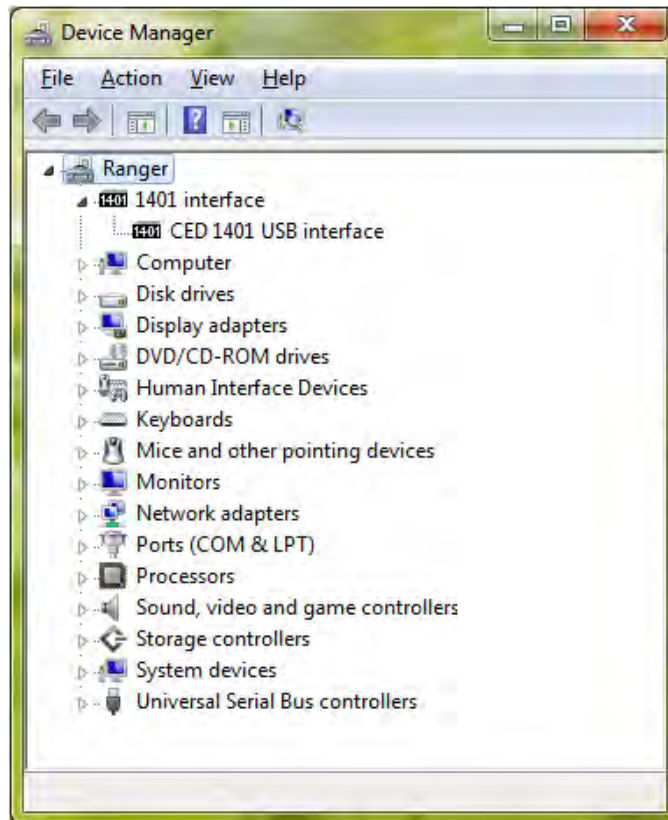

**USB interface
settings in Vista,
Windows 7,
Windows 8,
& Windows 10**

With the driver installed, the Power1401 becomes a recognized USB device, and the *CED 1401* icon will appear in the Device Manager whenever the Power1401 is plugged in and powered up. You can view the 1401 USB settings by selecting

Start, Control Panel, System

Open *System* by double-clicking, and select *Device Manager*. This reveals the hardware devices tree. The '1401 interface' icon will be on a node with an arrow ▷, indicating that a device is present. Click on this to display the 'CED 1401 USB interface' icon. Among the tabs revealed when this is opened, the *General* tab provides overall device status, and allows for enabling/disabling the device. The *Settings* tab allows you to set the 1401 device number if you have a multi-1401 installation.

**Device Manager,
view devices by type
(Windows XP)**

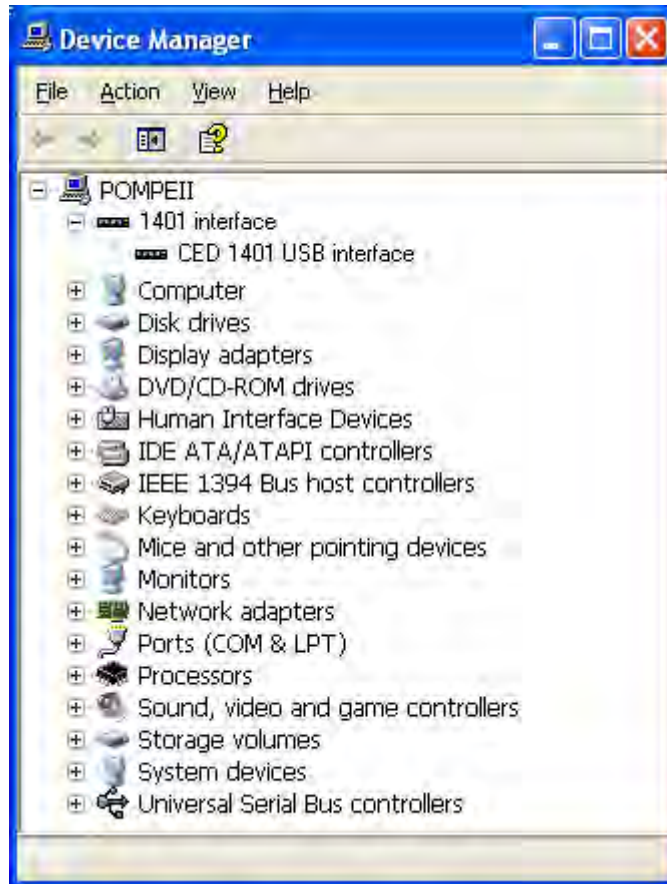

**USB interface
settings in
Windows XP**

With the driver installed, the Power1401 becomes a recognized USB device, and the *CED 1401* icon will appear in the Device Manager whenever the Power1401 is plugged in and powered up. You can view the 1401 USB settings by selecting

Start, Control Panel, System

Open *System* by double-clicking, select the *Hardware* tab and press the *Device Manager* button. This reveals the hardware devices tree. The '1401 interface' icon will be on a node with a boxed **+**, indicating that a device is present. Click on this to display the 'CED 1401 USB interface' icon. Among the tabs revealed when this is opened, the *General* tab provides overall device status, and allows for enabling/disabling the device. The *Settings* tab allows you to set the 1401 device number if you have a multi-1401 installation.

Installing test & diagnostics

Installing test & diagnostics The Power1401-3A installation CD-ROM includes utilities that verify correct installation of your Power1401, assist in recalibrating the analogue system, and diagnose hardware problems. This software is installed automatically at the same time as the driver, when `setup.exe` is run.

CED provides you with 1401 support for Windows in a CD. It can also be downloaded from our website, www.ced.co.uk.

To install from CD under any supported operating system:

- Insert the CD
- The installation program should run automatically
- If it does not, select *Start, Run, Browse...*, open the CD and choose the file `setup.exe`
- Click on *OK* and follow the screen instructions

If the 1401 drivers on the *CED 1401 installation* disk are newer than those on your system, `setup.exe` will update them.

Location of software You can choose where `setup.exe` copies the 1401 files. The default destination is `c:\1401`. In this case, 1401 utilities are copied into the `\1401\utils` subdirectory. This manual assumes you have accepted that default. `\1401` itself is the directory where 1401 commands are installed.

Windows diagnostics The Windows installation includes the utility TRY1401, that verifies that your Power1401 has been installed correctly, and runs diagnostic procedures.

TRY1401 TRY1401 is the principal test program for users. It is also installed as a utility in the program folders of CED applications such as Spike2 and Signal. It simulates a typical 1401 application program and exercises the host computer and Power1401 in the same way.

TRY1401 program screen, displaying 1401 Info... (Windows 10)

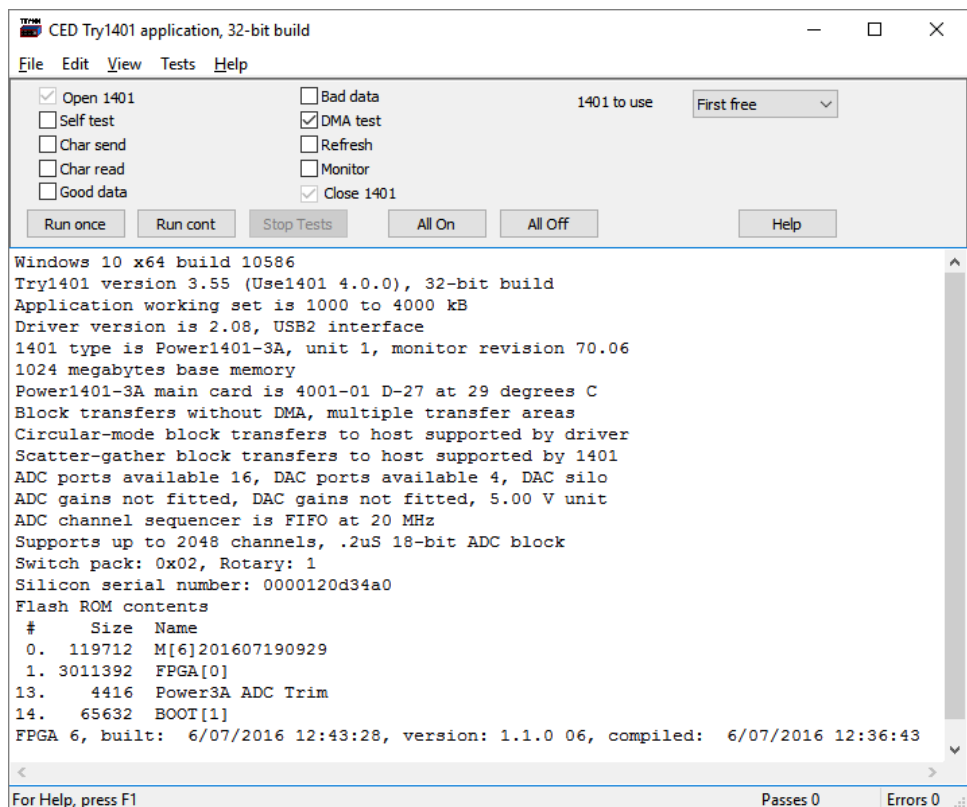

The TRY1401 utility is currently installed as the application TRY1432.exe. To run TRY1401, select

Start, All Programs, 1401 support, TRY1401

Running TRY1401 is self-explanatory. The check boxes allow different aspects of 1401 function to be tested separately. *Self test* causes the internal self-test hardware to run. Check this if the  LED starts to flash red and green after the Power1401 has been switched on. By clicking *Run cont*, the selected tests are run continuously, which can be useful for detecting intermittent faults.

1401 Info... To access the summary of hardware and firmware information shown on the TRY1401 screen on the previous page, select *File, 1401 Info...* from inside TRY1401.

ADC & DAC Test Event & Clock Test If you wish to test or re-calibrate the analogue hardware, or test the functions of the Clocks and Events, select *Tests, ADC & DAC Test* or *Tests, Event & Clock Test* from inside TRY1401. These are tests that the machine cannot do by itself since they require cables to be routed between various connectors, voltages set, &c. The tests are interactive. At each step the user is instructed what equipment is needed, what to do, and what results to expect. Analogue calibration is discussed more fully on page 41.

**ADC & DAC Test,
Ramp DAC test**

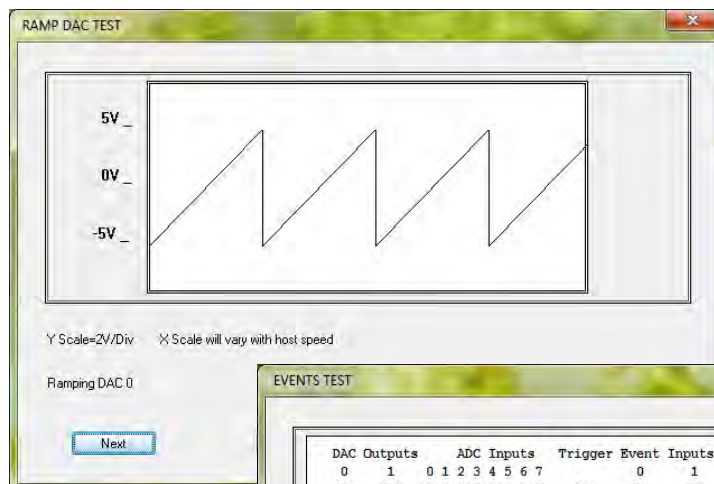

**Event & Clock Test,
Events test ➤**

DAC Outputs		ADC Inputs							Trigger	Event	Inputs	Dig	Outputs	Clock	P1401
0	1	0	1	2	3	4	5	6	7	(0)	0	1	0	1	oTest
(0)	(0)	0	0	0	0	0	0	0	0	(0)	(0)	(0)	(0)	(0)	oPower

Testing Event 0 input, high-going edge active
Connect Digital Output 0 to Event input 0

Press <Execute> to run test or <Exit> to exit

Execute Reppal Restart Exit

Application software: Spike2 & Signal

Running the Power1401 with Spike2

Spike2 is optimized for the analysis and recording of continuous data, possibly on many channels. Analysis of EEGs during sleep, or recording of cardiac output, blood pressure and respiration would be typical tasks. This application example, and the Signal application example below, make use of the CED 1902 isolated pre-amplifier.

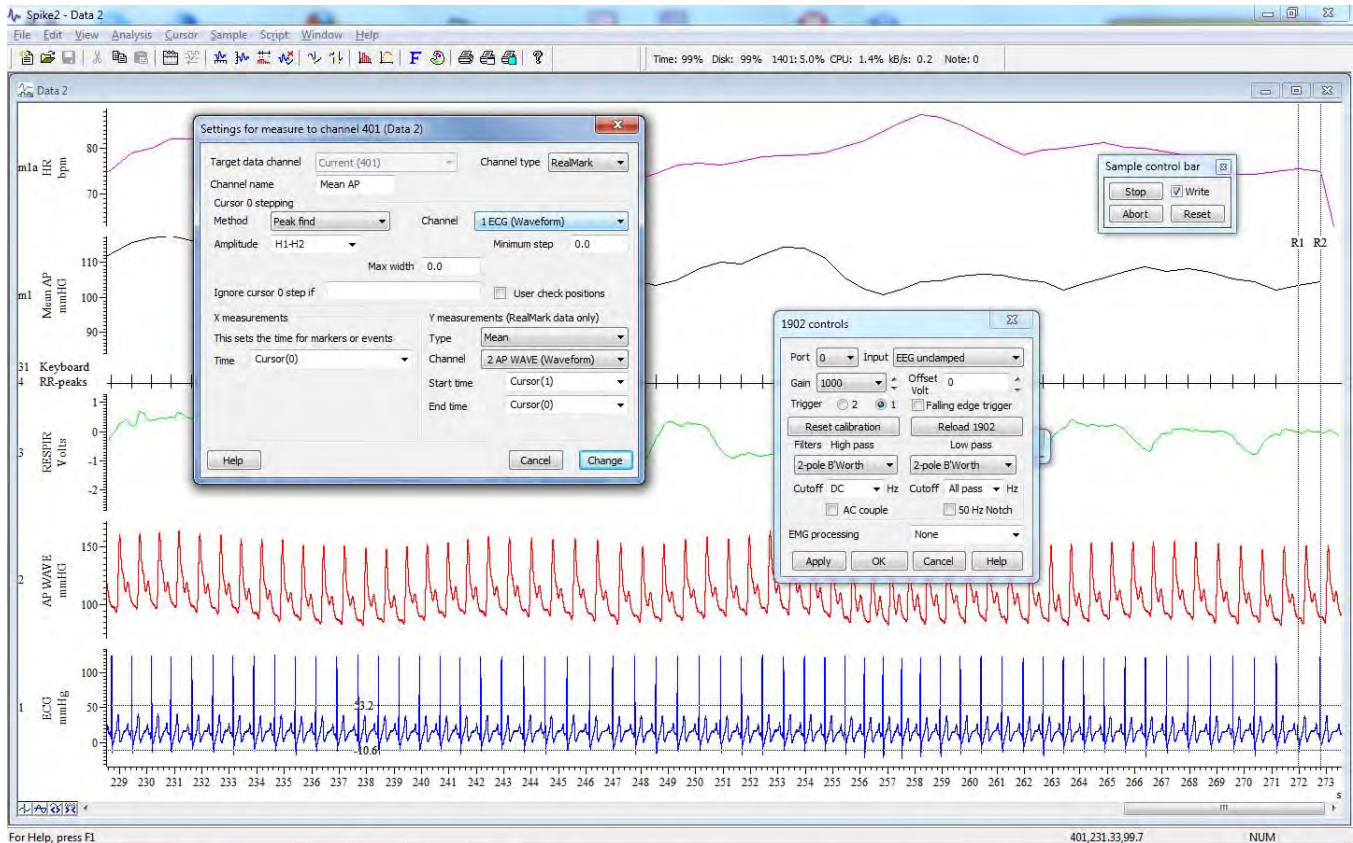

Spike2 sampling ECG, with 1902 control panel

Running the Power1401 with Signal

Signal is optimized for the analysis of sweep based information, where a sequence of data is recorded repetitively, often synchronized to a repeated stimulus. The classic example of this is evoked-response recording: here segments of brain activity are correlated with recurrent stimuli, in order to extract responses buried in the noise.

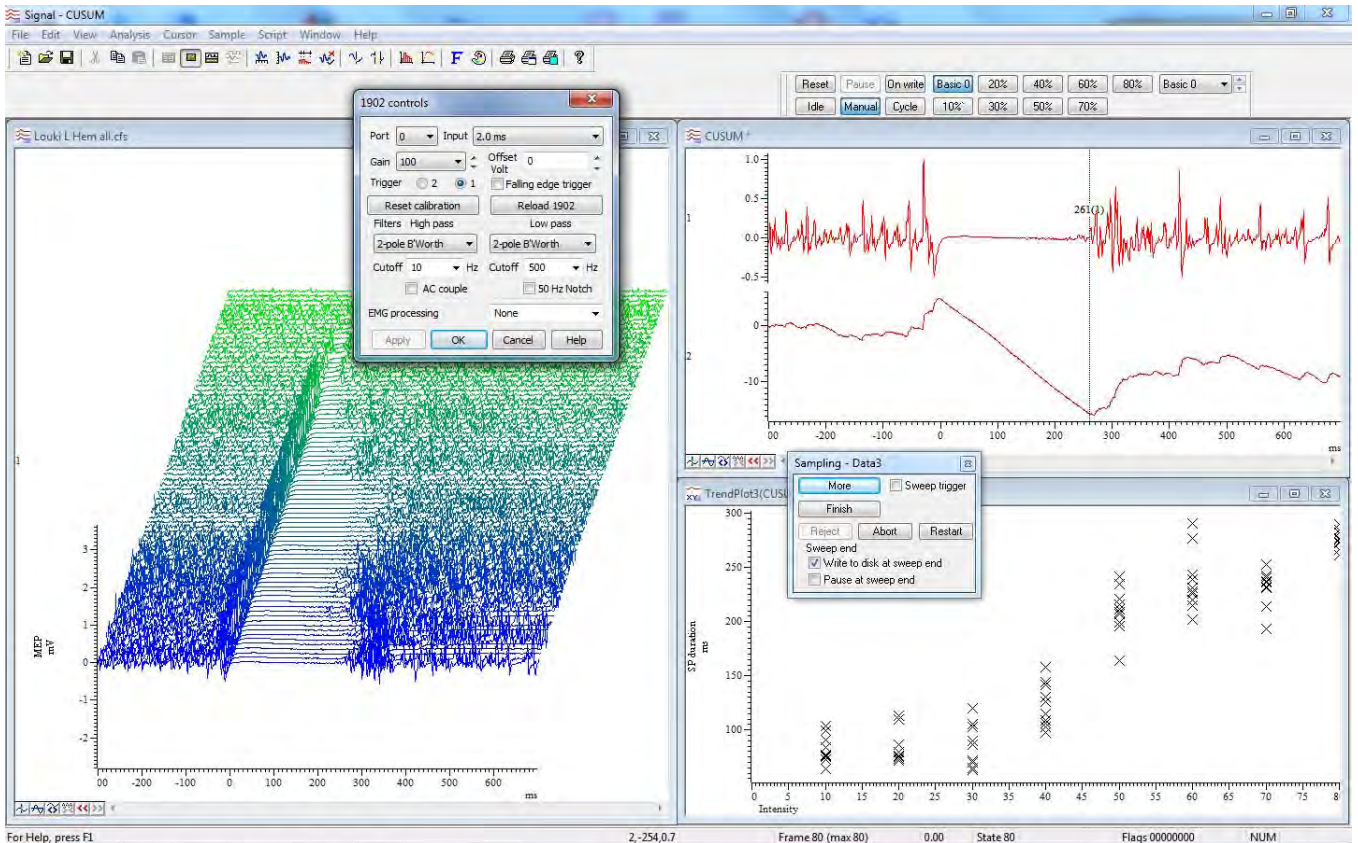

Signal controlling 1902s for multi-channel data acquisition

Input and outputs

General The following points deal with physical and electrical aspects of Power1401 connectors, rather than their electronic function.

Mains earth The outer sleeves of the front-panel BNCs, and the metal shells of the various rear-panel connectors, are robustly connected to the metalwork of the case and, via the earth pin of the DC inlet and the earth leads of the power brick, to mains earth. All signal returns are tied to mains earth on the printed circuit board. Items of equipment connected to the Power1401 must not be treated as isolated from mains earth, nor from each other.



Front-panel LEDs All front-panel BNCs have adjacent yellow LEDs. These flash or blink as appropriate, e.g. an ADC input LED may light when its channel is active. A DAC output LED may flash when its channel is updated. Digital output LEDs light when their bit is set. LEDs may light to prompt users to make connections. LEDs flash in a distinctive manner on self test. If all ADC and DAC LEDs turn on at once, and the  pushbutton LED turns off, this indicates the Power1401 is overheating. The pushbutton lights red to indicate self-test, and flashes red and green if a hardware error has been detected. Normally it glows green, indicating that none of the internal voltage rails has drifted outside limits. See also *LED diagnostic patterns*, page 44.

Externally-connected chips ICs connected directly to the outside world are susceptible to damage from electrostatic discharge or signal overload, though in practice this seems to happen only rarely. ADC inputs and DAC outputs are diode-clamped to ± 15 V. Digital-output ICs are diode-clamped to +5 V and ground. Digital-input and event-input signals are protected by MOSFET devices and are safe against moderate overvoltages of either polarity. However, if these measures fail, damaged ICs must be unsoldered and replaced. All such ICs are readily-available types. If ordering, specify the exact part-code as on page 36 to ensure lead-free parts. See page 35 for opening the Power1401 and page 36 for the location and identification of I/O chips. See page 45 for sending the 1401 back to CED.



Connector diagrams On the following pages, all rear-panel connectors are drawn as the user sees them, i.e. viewed from the *outside*. This is also the view of their mating connectors as seen while wiring them up!



Waveform input There are sixteen waveform input channels on a standard Power1401. Eight channels are available through front-panel BNC connectors, labelled ADC Inputs, and eight through the rear-panel Analogue Expansion D-socket. All inputs pass through ferrite chokes that block high-frequency noise. The working input range of the ADC (and the DAC outputs) is ± 5 V or ± 10 V, as selected in the TRY1401 utility. The choice is retained in the SPI flash memory and is unaffected by power cycling. See page 39 for setting the ADC input range.

Waveform buffering & gain Waveform input channels are buffered through amplifiers. If the programmable-gain option is fitted, the amplifier gains are individually software-settable to unity, $\times 2$, $\times 5$ or $\times 10$. Channels are then steered into the ADC (Analogue to Digital Converter) via multiplexers. The ADC can convert an input signal to a 16-bit digital value at up to 3 MHz in single-channel mode, 1 MHz if switching channels. Sampling is inherently sequential; two channels cannot be sampled simultaneously.

Trigger The front-panel input labelled Trigger can be set by software to be the external signal to start the clock that controls ADC conversions. When operating in internally-triggered mode the ADC typically samples at a fixed rate set by one of the clocks.

External convert The ADC external convert input is also permanently wired through pin 6 of the rear panel Events D-socket. Conversions are usually initiated by a high-to-low transition. External convert signals are used when the conversion time is determined by an external event, e.g. when synchronizing conversions to the phases of a rotating machine.

ADC LEDs The front-panel waveform input channels each have an associated yellow LED. They are controlled by software command and typically turn on when the channel is in use.

Trigger LED The trigger-input LED flashes or blinks on detection of an active-edge transition at the Trigger input. The LED can be set by software to be either on or off in the quiescent state.

Technical details: The input impedance of the waveform channels is 1 megohm.
Analogue input The waveform inputs should be driven from a low-impedance source (100 ohms or less): the output of most amplifiers is suitable. The maximum non-destructive input voltage range is ± 15 V. If you do overdrive the inputs, the input buffer amplifiers may be damaged. Replacing them requires soldering quite small devices; see page 35 for opening the Power1401, and page 36 for the exact part number to ensure lead-free parts. See page 45 for sending the unit back to CED.



Front-panel Trigger input The front-panel Trigger input has a working voltage range of 0 V to +5 V. MOSFET circuit protection allows a safe input range of ± 10 V. This input is pulled up to +5 V by a 100 kilohm resistor and has input hysteresis: the low-going threshold voltage is 0.95 V and the high-going threshold is 1.2 V. Pulses driving the trigger input should be 1 μ s or longer. To pull this input low, the driving device must be able to sink 50 μ A.

Rear-panel ADC external convert input The rear-panel ADC external-convert input is on pin 6 of the Events D-socket. It responds to TTL and switch closure signals, and has a working voltage range of 0 V to +5 V. MOSFET circuit protection allows a safe input range of ± 10 V. This input is pulled up to +5 V by a 10 kilohm resistor. Input pulses should be at least 1 μ s long and must fall below 0.8 V for guaranteed recognition. Conversion is normally initiated on the high-to-low edge. Use of the rising edge can be selected by switch; see page 35.

The ADC The ADC and the FPGA firmware resolve the analogue input voltage into 65536 levels (sixteen-bit precision). Each step is 150 μ V approximately at ± 5 V input range, or 300 μ V at ± 10 V. The ADC has eighteen-bit resolution, but the extra bits are used to simplify calibration of the analogue input.



Waveform output There are four, and optionally eight, waveform output channels on the Power1401. Two are on front-panel BNC connectors, labelled DAC Outputs (Digital to Analogue Converters), and two on the rear-panel Analogue Expansion DD-socket. If extra DACs have been fitted, their outputs may also be routed on the PCB to the rear panel DD-socket, or else routed by internal coax cables to BNC socket outputs on an expansion top-box. All outputs pass through ferrite chokes that block high-frequency noise.

Analogue voltage range The DAC waveform outputs generate voltages in the range ± 5 V, in steps of approximately $150 \mu\text{V}$ (16-bit precision). The output range may be changed to ± 10 V, and $300 \mu\text{V}$ steps, by software option. The selected range applies to all four (or eight) DACs and also the ADC inputs. The setting is retained in non-volatile SPI flash, unaffected by power cycling. See page 39 for setting the DAC output range.

Update modes The DACs can be programmed to update in response to an external signal, either the rear-panel Event Clock F input (see page 22), or the front panel Trigger input, so as to synchronize the update rate with external equipment. Alternatively, they can be updated at a fixed rate set by one of the internal clocks. When outputting multiple channels of waveform, the Power1401 can be programmed to update several DACs simultaneously. The maximum update rate is 500 kHz.

DAC LEDs The front-panel DAC output channels each have an associated yellow LED. The LED is controlled by software and typically turns on when the channel is in use.

Technical details The waveform outputs expect to drive loads of 600 ohms' impedance or more, and are short-circuit proof. For full accuracy, the load should be at least 5 kilohms. If an output amplifier is damaged it must be unsoldered and replaced. See page 35 for opening the Power1401. See page 36 for the exact part number to ensure lead-free parts. See page 45 for sending the machine back to CED.



The rear-panel analogue connector The rear-panel analogue connector is a 44-way high-density DD-socket. On an unexpanded, four-DAC Power1401 it accommodates ADC input channels 8 - 15 and DAC channels 2 and 3. (For rear-panel channel numbering on expanded units, see below.) The ten signals are on the bottom row of the D-socket, and each has its own ground return on the top row. This is convenient when wiring-up the mating plug with twisted pairs or coaxial cables. The middle row is unconnected, unless the four extra DACs, DAC channels 4 - 7, have been fitted and routed to the rear panel. All signals and returns pass through ferrite chokes that block high-frequency noise.

Rear-panel channel numbering The rear-panel ADC inputs are defined always to be the last eight channels available. So, if a sixteen-channel ADC expansion top-box is fitted, its channels become 16 - 23 and the rear-panel inputs become ADC channels 24 - 31; if a Spike2 top-box is fitted, with eight ADC channels, the rear-panel inputs become channels 16 - 23.

The rear-panel DAC outputs are similarly defined to be the last pair (or more) in use. So, if the Signal top-box is fitted, its DACs become 2 - 5, and the rear-panel DACs become 6 and 7; were the four extra DACs also fitted to the motherboard, they would become 8 - 11.

Rear-panel
analogue socket

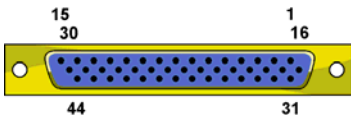

Pin	Function	Pin	Function
1, 2	No connection	27	DAC 6 output *
3	ADC 8 return	28	DAC 6 return *
4	ADC 9 return	29	DAC 7 output *
5	ADC 10 return	30	DAC 7 return *
6	ADC 11 return	31, 32	No connection
7	ADC 12 return	33	ADC 8 input
8	ADC 13 return	34	ADC 9 input
9	ADC 14 return	35	ADC 10 input
10	ADC 15 return	36	ADC 11 input
11, 12	No connection	37	ADC 12 input
13	DAC 2 return	38	ADC 13 input
14	DAC 3 return	39	ADC 14 input
15	No connection	40	ADC 15 input
16 - 22	No connection	41, 42	No connection
23	DAC 4 output *	43	DAC 2 output
24	DAC 4 return *	44	DAC 3 output
25	DAC 5 output *		
26	DAC 5 return *	Shell	Mains earth to cable screen

* These signals are present if the relevant DACs have been fitted and connected to the rear-panel analogue socket, otherwise the pins are no connection.

A suitable mating D-plug, with solder-bucket terminations, is ITW McMurdo part-number HDB44PTD. A suitable shroud is also required.



Clocks The Power1401 has five clocks, used for timing and counting external pulses (clocks 0 and 1), generating general-purpose timing pulses (clock 2), controlling waveform output (clocks 3 and 4) and controlling the waveform input sampling rate (clock 4). These clocks are managed automatically by the application software.

Trigger You may need to drive a clock from an experiment, e.g. to trigger sweeps of waveform sampling. The front-panel Trigger input will be routed by software to the correct clock, to set it running on your signal.

Clock output You may require the application to generate pulses to drive an experiment. The output of Clock 2 is available from the front-panel Clock BNC connector. Frequencies between 10 MHz and 3.55 nHz (one pulse in 8.9 years!) can be generated. The application manual describes this where it is relevant.

Clock inputs Where external signal pulses are to be timed or counted, the application program may use the front-panel Event 0 and Event 1 inputs. Pulses must be 1 μ s or wider. If there are more than two such signals, the rear-panel Digital Inputs may be used; see page 26.

Frequency sources All clock frequencies are normally derived from an internal crystal oscillator. Users may sometimes require a timing source from outside the Power1401 instead. All clocks can be driven from an external frequency source via the Clock F input, pin 7 on the rear-panel Events D-socket (see page 22). When you need to synchronize two 1401 machines, use the synchronization port (see page 27).

LEDs The trigger and event-input LEDs flash or blink on detection of an active-edge transition. They can be either off or on in the quiescent state, as set by software, the latter to show that the input is armed and ready to be used. The Clock output LED simply indicates that Clock 2 is running, turning on whenever Clock 2 is enabled.

Frequency synthesizer The frequency synthesizer is an internal device capable of generating frequencies that cannot be obtained by simple integer division of the 25 MHz crystal oscillator. An example of this would be the 44.1 kHz sampling frequency widely used in digital audio applications. Two such frequencies can be generated independently by the frequency synthesizer. The outputs may be used internally, e.g. to control ADC sampling rate or DAC update rate, or routed to the Clock 2 output.

The frequency synthesizer is not currently (August 2016) supported in application software.

Technical details The normal input range of Trigger, Event 0 and Event 1 is 0 V to +5 V. There is MOSFET circuit protection allowing a safe input range of ± 10 V. These inputs are held internally to +5 V by 100 kilohm resistors and have input hysteresis: the low-going threshold voltage is set at 0.95 V and the high-going threshold at 1.2 V. To pull these inputs low, the driving device must be able to sink 50 μ A. Pulses driving these front panel inputs must be 1 μ s or wider.



Clock is an output, driven by an SN74LVC1T45DRL lead-free, surface-mount bus driver element which can source or sink 24 mA. Note that, since this is an output device, it cannot have MOSFET protection. If it is damaged, its replacement will involve unsoldering and resoldering. This is a very small device, less than 2 mm square.

Trigger, Clock 2, Event 0, and Event 1 all pass through ferrite chokes that block high-frequency noise.



Event inputs More clock-related inputs, the Clock E series, are provided on the rear-panel Events D-socket. These allow close control of the clocks for 1401 programmers. Full details are given in the *1401 family programming manual*, and the *Power1401-3A technical manual*. The front-panel BNCs Event 0 and Event 1 are often routed by software to the Clock E0 and E1 inputs.

Technical details Clock E and Clock F inputs respond to TTL or switch closure signals, and are pulled up to +5 V by 10 kilohm resistors. To pull these inputs low, a driving device must sink at least 500 μ A; to guarantee recognition, input pulses must fall below 0.8 V. Clock E pulses must be at least 100 ns wide. Clock F frequency must not exceed 10 MHz; pulses should be 50 ns or wider. The working range of these inputs is 0 V to +5 V. MOSFET circuit protection allows a safe input range of ± 10 V.

The sense of the Clock E and ADC external convert inputs may be inverted by a switch option, see page 35, but the inputs would all then be held active high if no input is connected.

Event Out The Event Out output is buffered by an SN74LVC1T45DRL single-gate, lead-free, surface-mount buffer that can source or sink 24 mA. Since this is an output device it cannot have MOSFET protection. If it is damaged, its replacement will involve resoldering. Event Out is normally isolated from the rear-panel socket and a motherboard jumper must be inserted to make it available (see page 37). This is to help reduce EMI.



Events socket

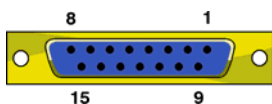

Pin	Function	Pin	Function
1	Clock E0 input	5	Clock E4 input
2	Clock E1 input	6	ADC external convert input
3	Clock E2 input	7	Clock F input for all clocks
4	Clock E3 input	8	Event Out output
9 - 15	Ground	Shell	Mains earth to cable screen

The mating D-plug, with solder-bucket terminations, is ITW McMurdo part-number DA15P. A shroud is also required.

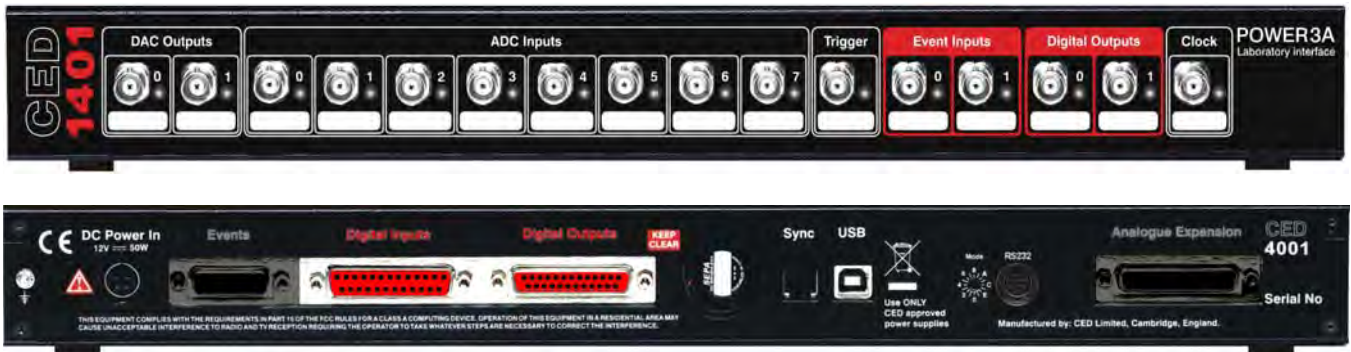

Digital input and output The Power1401 has full, sixteen-bit digital I/O available on the rear-panel D-connectors Digital Inputs and Digital Outputs. Bits may be read or written singly, by low or high byte, or by the whole word.

Front-panel BNCs The front-panel Event Inputs can be fed into bits 0 and 1 of the high byte and/or the low byte of the digital inputs if enabled by software. Bits 0 and 1 of the high byte of the digital output are also routed to the front-panel Digital Outputs.

The input high byte can be programmed for detection and timing of change of state (i.e. any bit changing either way). Digital output can be gated with clock 2 so that it updates on clock 2 ticks. Digital output is normally permanently enabled, but either or both bytes can be turned tristate-off by grounding pin 11 of the output socket, if this has been enabled by software. These bytes are re-enabled whenever pin 11 is high or disconnected.

Digital I/O LEDs Front-panel event-input LEDs flash or blink on detection of active-edge transitions, the quiescent state being set by software command. Front-panel digital-output LEDs simply reflect the state of the bits, being lit whenever their bit is set (high).

The 1-Wire port The Power1401-3A is provided with a 1-Wire port on pin 22 of the input connector. This allows bidirectional communication down a single wire (plus ground) to one or more devices, which are also powered from the same wire. Devices currently available include temperature and humidity sensors, as well as 'silicon serial numbers'.

The 1-Wire port is not currently (August 2016) supported in application software.

Digital I/O handshake protocol

Digital data transfer between the Power1401 and external equipment can optionally be synchronized by pairs of handshake signals. There are separate pairs for each byte. The polarities of all signals can be set independently by software. The example that follows is typical.

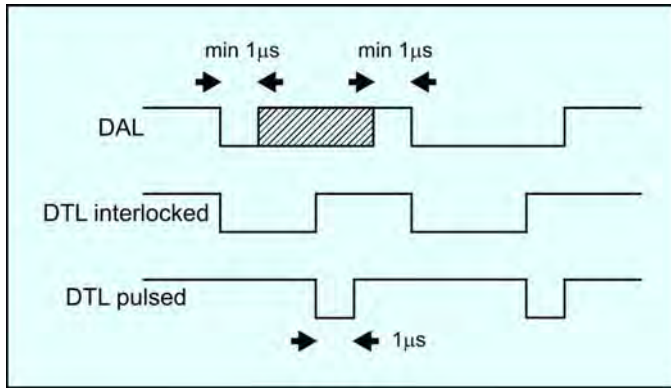

When presenting data, an external device sends a pulse at least 1 μ s wide to the DAL input (data available, 0 - 7). When the Power1401 reads the data the DTL output line (data transmitted, 0 - 7) pulses for 1 μ s if in pulsed mode. If in interlocked mode, DTL is set by the Power1401 read and cleared by the next DAL.

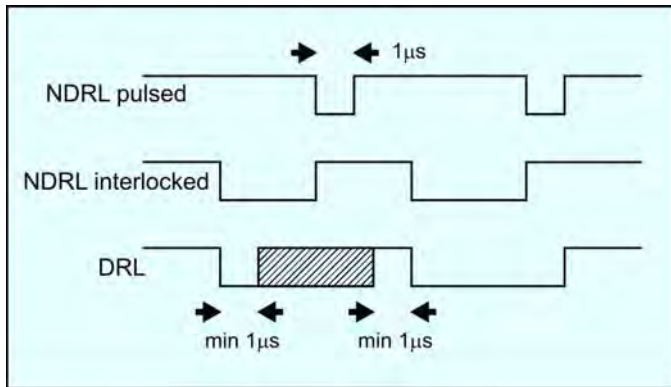

When Power1401 writes data to the digital output, the NDRL output (new data ready, 0 - 7) pulses for 1 μ s if in pulsed mode. If in interlocked mode NDRL is set by the data write and cleared by the answering DRL pulse (data read, 0 - 7), at least 1 μ s wide, from the external device.

5 volt output and circuit breaker

There is a +5 V output available on pin 25 of both the digital input and output ports. This output is internally protected by a 200 mA circuit-breaker and is intended only to power one or two chips for interfacing purposes. The circuit-breaker is reset by removing power from the Power1401.

We have occasionally had problems with users who trip this protection very regularly. This is usually caused by a connector with a metal shroud being plugged into the digital input crookedly and the shroud shorting to pin 25, which causes overload. If you have this problem, the simple solution is to make this connection with Power1401 switched off, or to use a connector with a plastic shroud.

Technical details



All digital inputs have MOSFET circuit protection. All outputs are buffered through SN74LVC8T245PW octal, or SN74LVC1T45DRL single-gate, lead-free, surface-mount devices, which can source or sink 24 mA. Note that, since these are output devices, they cannot have MOSFET protection. If any are damaged, their replacement will involve unsoldering and resoldering. The single-gate devices are very small, less than 2 mm square.

Unconnected digital inputs read 1, being pulled internally to +5 V by 4.7 kilohms (at the rear panel) or 100 kilohms (at the front panel). Input voltages of more than 2.0 V will always read as a logic 1. To appear as a logic 0, the input must be pulled down below 0.8 V for at least 1 μ s, requiring approximately 50 μ A, at the front panel; or 100 ns, requiring approximately 1 mA, at the rear panel.

On the front panel, Digital In 0 and Digital In 1, Digital Out 0 and Digital Out 1 all pass through ferrite chokes that block high-frequency noise.

Digital I/O connectors

Digital Input plug

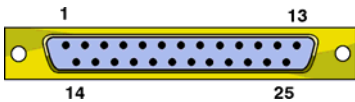

Digital Output socket

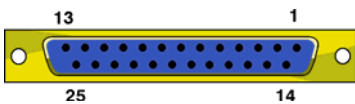

Pin	Output function		Pin	Input function	
1	High byte out	Word out	1	High byte in	Word in
14	6	14	14	6	14
2	5	13	2	5	13
15	4	12	15	4	12
3	3	11	3	3	11
16	2	10	16	2	10
4	1	9	4	1	9
17	0	8	17	0	8
5	Low byte out	Word out	5	Low byte in	Word in
18	7	7	18	7	7
6	5	5	6	5	5
19	4	4	19	4	4
7	3	3	7	3	3
20	2	2	20	2	2
8	1	1	8	1	1
21	0	0	21	0	0
9	DRH Data received 8-15	i/p	9	DTH Data transmitted 8-15	o/p
22	User i/p (buffered, reserved)		22	1-wire port	i/o
10	User o/p (buffered, reserved)		10	Not connected	
23	NDRL New data ready 0-7	o/p	23	DAL Data available 0-7	i/p
11	Output disable	i/p	11	Not connected	
24	DRL Data received 0-7	i/p	24	DTL Data transmitted 0-7	o/p
12	NDRH New data ready 8-15	o/p	12	DAH Data available 8-15	i/p
25	+5V (200mA maximum)		25	+5V (200mA maximum)	
13	Ground		13	Ground	
Shell	Mains earth to cable screen		Shell	Mains earth to cable screen	

The mating connectors, with solder-bucket terminations, are ITW McMurdo part-numbers DB25P (25-way plug) and DB25S (25-way socket). Suitable shrouds are also required.

USB port The USB port is used to connect the Power1401 to the PC. Both USB1 and USB2 standards are supported. Data transfer rates can reach approximately 38 MBytes/sec for USB2.

The USB port is a style B socket on the rear panel. USB_DATA+ and USB_DATA- transmit the serial data as a differential pair.

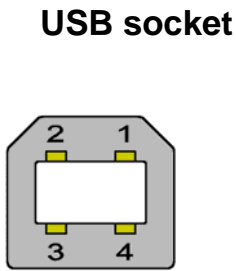

Pin	Function
1	USB +5V (USB cable detect)
2	USB_DATA+
3	USB_DATA-
4	USB_GND (to system ground)
Shell	Mains earth to cable screen

USB_GND is connected to system ground via a choke. USB_+5V is used as a cable sense input, also via a choke. +5 V applied to this pin indicates that the USB cable is inserted. The Power1401 is specified to meet European and US EMC regulations *only* if used with braid-screened cables supplied by CED.

Synchronization port The synchronization port enables two or more 1401s to be synchronized (Power-3A, Power-3, Power II, micro-3, micro mk II or Power serial no. P 3xxx onwards, in any mix), so that there is absolutely no drift in timing between units.

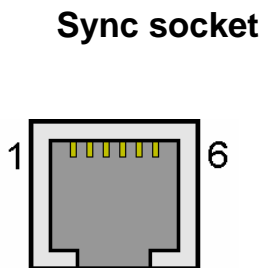

The Sync socket is an RJ11 connector with 6 pins loaded. A

Pin	Function
1	MHZ20_TRx-
2	MHZ20_IN-
3	MHZ20_IN+
4	MHZ20_OUT-
5	MHZ20_OUT+
6	MHZ20_TRx+
Shell	Mains earth to cable screen

screened cable is daisy-chained from unit to unit, with the 'master' end of the cable determining which unit provides the clock frequency. Up to three 1401s may be synchronized with the master. The units need to be in close physical proximity, either side by side or stacked.

RS232
8-way mini-DIN



Pin	Function
1	CON_DTR
2	CON_CTS
3	CON_RX
4	Ground
5	CON_TX
6,7	No connection
8	Ground
Shell	Mains earth to cable screen

The RS232 port is only used during the initial setup and for debugging. Under working conditions the Power1401 cannot be programmed via RS232 so this port is not available for users. Its pinout is given here only for the sake of completeness.

DC power inlet

The external power brick is a switch-mode mains power supply that provides a nominal 12 V DC. This is converted to the required voltage rails inside the Power1401. The internal convertors will accept voltages in the range +9 V to +18 V, so the Power1401 will run off a car battery, for example.

An internal relay controlled by the front-panel pushbutton switches both +12 V and 0 V. When inserting the DC supply plug, initial contact is made by mains earth when the sleeve engages the DC inlet screen. Mains earth also makes contact via a pin at the same time as the +12 V and 0 V pins.

DC power socket

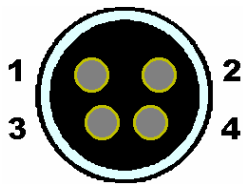

Pin	Function
1	+12 V
2	0 V
3	SPARE
4	Mains earth
Shell	Mains earth to cable screen

The unexpanded Power1401 will consume approximately 1.3 A at 12 V. This can rise to up to 2.8 A if the Power1401 is fitted with top-boxes.

Hardware expansion



The ADC16 top-box: 16 waveform inputs

You may increase the number of waveform inputs by adding the ADC16 expansion top-box with sixteen extra channels, which are mapped onto ADC channels 8 - 23. The rear-panel ADC inputs are then mapped onto channels 24 - 31. Once the Power1401 has been told about the extra channels by the TRY1401 utility, the new ones may be freely used just like the basic set. Software that attempts to read the extra channels will return undefined data values if the ADC16 is not installed.

Two ADC16s may be added to a Power1401, in which case the second maps onto channels 24 - 39 and the rear-panel ADC inputs map onto channels 40 - 47.

The ADC inputs on the ADC16 are of identical design to the ones on the main board, with optional selectable gains of unity, $\times 2$, $\times 5$ or $\times 10$. The input range will be ± 5 V or ± 10 V as set on the motherboard using TRY1401 (see page 39). The top-box makes internal connections to the Power1401 motherboard. This expansion board, the CED 4001-03, requires the Power1401 expanded mechanics (can and case). It is usually more convenient to send an unexpanded unit back to CED for upgrading than for the end-user to install the expansion unit.



The PGA16 top-box: 16 programmable-gain ADC inputs

Like the ADC16, the PGA16 top-box provides sixteen more ADC input channels mapped onto channels 8 - 23 (and the rear-panel ADC inputs onto 24 - 31). In this case, however, each channel has two stages of individually-programmable gain. Typically the first stage will have gains of unity, $\times 2$, $\times 5$ and $\times 10$, and the second stage gains of unity, $\times 10$ and $\times 100$. In this way gains of up to $\times 1000$ are achievable.

Two PGA16s may be added to a Power1401, in which case the second maps onto channels 24 - 39 and the rear-panel ADC inputs map onto channels 40 - 47.

The ADC inputs are of similar design to the ones on the main unit, only with two cascaded gain stages. The input range will be ± 5 V or ± 10 V as set for the motherboard using TRY1401 (see page 39). The top-box makes internal connections to the Power1401 motherboard. This expansion board, the CED 2701-04, requires the Power1401 expanded mechanics (can and case) and it is usually more convenient to send an unexpanded unit back to CED for upgrading than for the end-user to install it.



The Signal top-box: 4 extra DACs The Signal top-box is designed for customers that require a larger number of DACs than usual. It provides another four, which are mapped onto DAC output channels 2 - 5. Additionally, the two rear-panel DACs on the Power-3A main board are brought out to BNCs on the top-box. Thus there are eight DACs in total, all available from front-panel BNCs.

The Signal top-box also provides eight channels of ADC input, mapped as channels 8 - 15. The inputs are of identical design to the ones on the main unit, with optional selectable gains of unity, $\times 2$, $\times 5$ or $\times 10$, and input range of ± 5 V or ± 10 V as set on the motherboard. The rear-panel ADC inputs are mapped onto channels 16 - 23.

The top-box also brings two more bits of digital output, bits 2 and 3 of the upper byte, to front-panel BNCs.

The top-box makes internal connections to the Power1401 motherboard. This expansion board, the CED 2701-05, requires the Power1401 expanded mechanics (can and case), and it is usually more convenient to send an unexpanded unit back to CED for upgrading than for the end-user to install it.



The Spike2 top-box: digital BNC connections In some circumstances, such as in many Spike2 applications, the digital inputs and outputs are heavily used for signals. It is convenient to have more of these connectors available on the front panel as BNCs. The Spike2 top-box provides six event inputs, mapped onto bits 2 - 7 of the digital inputs high-byte.

This expansion board also provides eight ADC inputs mapped onto ADC 8 - 15, of identical design to the ones on the main unit, with optional selectable gains of unity, $\times 2$, $\times 5$ or $\times 10$, and input range of ± 5 V or ± 10 V as set on the motherboard. Finally there is a pair of DACs mapped onto DAC 2 - 3.

When this card is installed, the rear-panel ADC inputs are mapped onto channels 16 - 23, and the rear-panel DACs onto channels 4 and 5.

The normal input voltage range of the digital inputs is 0 V to +5 V. The safe range is ± 10 V, and they present an impedance of 100 kilohm, as with the front-panel Event and Trigger inputs. The top-box makes internal connections to the Power1401 motherboard. The expansion board, the CED 2701-09, requires the Power1401 expanded mechanics (can and case) and it is usually more convenient to send an unexpanded unit back to CED for upgrading than for the end-user to install it.

Construction The Power1401-3A, like all its predecessors, is built on a single circuit board, the ‘motherboard’. This can accept up to two ‘daughterboards’ as expansion. Daughterboards are bolted to the motherboard on pillars that space the cards 1 U (1¾" or 44.45 mm) apart, a ‘U’ being the unit vertical spacing in 19-inch rack-mount equipment.

The inner can The motherboard (plus any daughterboards) is accommodated in the inner can, a clamshell of folded sheet steel. This is a very rigid structure, on account of the folds in the metal and the box-section formed by the baseplate and the motherboard. The sides of the motherboard protrude from the clamshell and engage with card guides in the outer case. The inner can provides mechanical protection and electrical and magnetic shielding.

Inner can expansion In an unexpanded Power1401-3A the clamshell comprises two pieces, the tray and the lid, with the motherboard clamped in between. Expanded units have a lid stretched to 2 U or 3 U, and an extender panel bolted onto the front face of the tray to raise its height to 2 U or 3 U.

The outer case The outer case of the Power1401-3A is built from 1-U aluminium extrusions. The side pieces have integral card-guides into which the inner-can assembly slides. The front and rear panels are bolted to the side pieces. The top and bottom plates are plastic-coated steel panels that slide into grooves in the side pieces and are retained by the front and rear panels. The screws securing the front panel are covered by the front-panel artwork sticker and consequently inaccessible in built units. Power1401s are supplied with lugs which bolt onto the outer case, for customers who wish to rack-mount their Power1401.

Outer case expansion Double- and triple-height outer cases are built from 1-U sections bolted together by ‘stacker bars’, which are metal spacers that fit between the side pieces. In each section, the front panel and side pieces are treated as a unit since the screws holding them together are hidden under the front-panel sticker. Expansion rear panels are blank. Assembling an expanded outer case involves screwing the front-and-side sections together with stacker bars, sliding-in the inner-can assembly and the top and bottom panels, then screwing-on the rear panels.

Earthing All metallic parts of the Power1401 enclosure are earthed. The inner can is tied to the earth rail of the circuit board via the screws that fix the board to the inner-can tray. The outer case is earthed by stout wires running from eyelets screwed to the outer-case metalwork to a spade tag connected to PCB earth. Expansion daughterboards are earthed via the brass spacer pillars. Earth continuity throughout the enclosure is ensured by metal-to-metal contact where parts are screwed together. There is a threaded M3 earth stud on the rear panel, for the earthing of auxiliary equipment. The Power1401 earth rail is connected to mains earth via the DC power socket and the earth leads of the power supply.



Upgrade by users For most kinds of daughterboard it is feasible for a user to expand a Power1401 in the field, though we do prefer units to be sent back to CED. No particular electronic expertise is required: the task should be well within the capability of an averagely practical person. Normal precautions against electrostatic discharge need to be taken. The expansion kit is quite economical since all parts of the unexpanded enclosure are reused apart from the inner-can lid. Detailed instructions are included in any expansion kit sent out to customers, as is a 2mm hex driver for the rear-panel screws. Opening a Power1401 is described on page 35.

Recalibration After a user has installed an expansion card in the field, it will be necessary to recalibrate the unit. Analogue gain is set by precision resistors at the time of manufacture and is not adjustable, but zeroing the offset to match the motherboard has to be done *in situ*. The user will have to run the calibration program, as described on page 41. This requires an accurate digital voltmeter (DVM) having a resolution of 10 μ V on the ± 5 V range.

Maintenance operations

Introduction The Power1401 requires very little maintenance. This section covers simple operations that may occasionally need the case opened, such as setting the internal options switch, replacing damaged I/O chips, upgrading memory, or re-calibrating the analogue system. We also describe updating the flash ROM.

Taking the lid off To open the Power1401, turn the unit off and disconnect the power lead and any other cables. Unscrew the four M3 screws at the corners of the rear panel (or panels) with a 2 mm hex wrench. Do not unscrew the green & yellow earth wire. Slide out the top cover. Be careful not to splay the sides: the case loses rigidity once the back is off.



The inner can is now visible. Slide it out to the rear, and unplug the green & yellow earth wire from the side. It may be quite tight. Undo the six M3 'combi' screws (with captive shakeproof washers) holding the lid on, using a 1-pt Pozidriv screwdriver. Gently pull the lid up and off. Note the position of the graphite-impregnated gasket strips. They are quite delicate, so store them safely. The circuit board is now ready to be worked on.

To reassemble the Power1401, simply reverse this procedure.

Switch settings This diagram shows the internal options switch settings on the Power1401. Logically, On counts as 0, Off as 1. Most options concern self-test and debug. Normally, all switches must be On, physically towards the edge of the circuit board, as shown.

SW 2 O P T I O N S		
8	<input type="checkbox"/>	1 = Loop mode on start
7	<input type="checkbox"/>	1 = Long memory test, tighter analogue limits
6	<input type="checkbox"/>	1 = Special DigI/O cables fitted for self-test
5	<input type="checkbox"/>	1 = No wait for host handshake on power up
4	<input type="checkbox"/>	1 = Invert ADC External Convert & Events
3	<input type="checkbox"/>	1 = Force DDR memory 2T mode off
2	<input type="checkbox"/>	1 = Show more serial line output during test
ON 1	<input type="checkbox"/>	1 = Continuous self-test

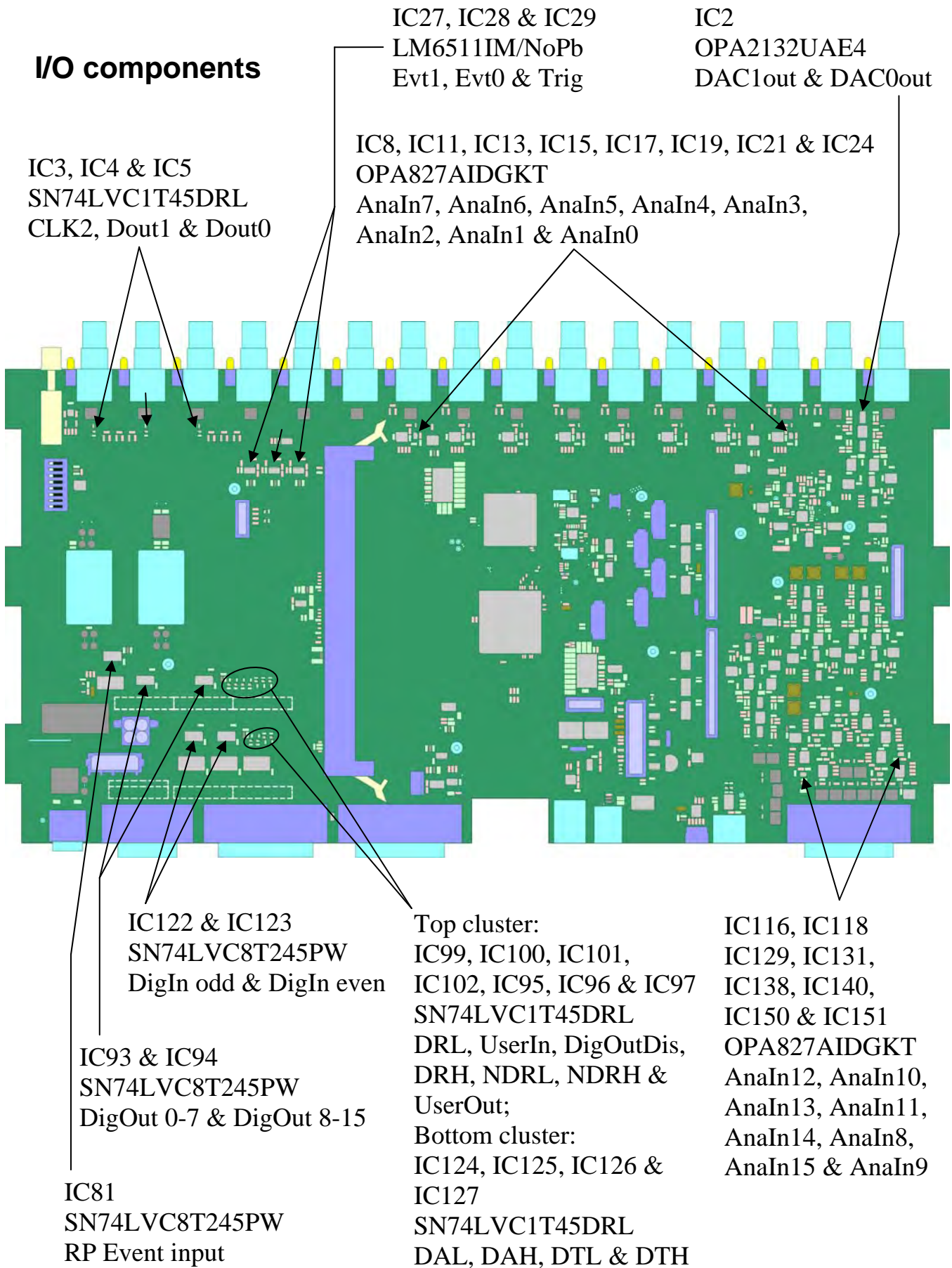

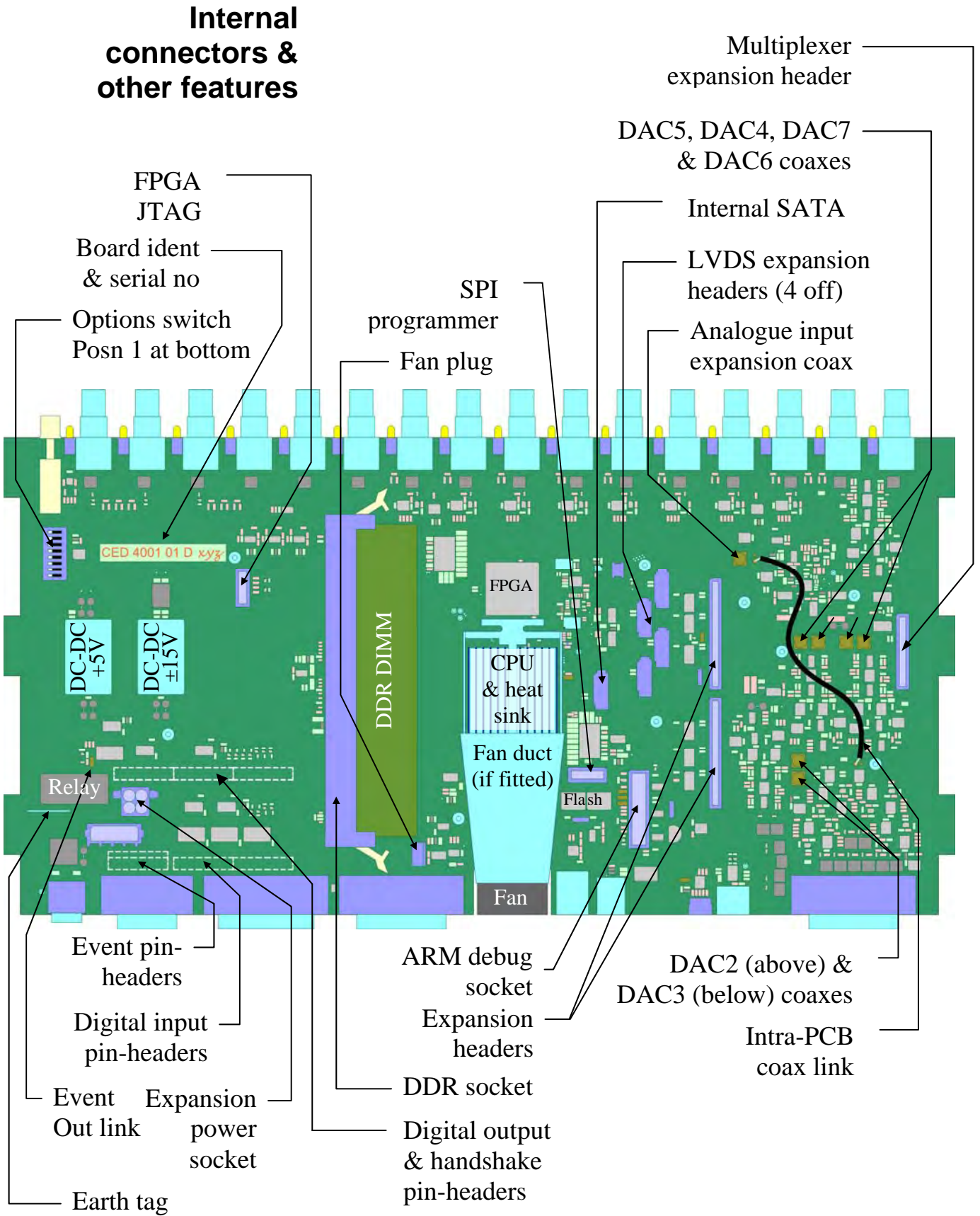

Memory upgrades The base-level Power1401-3A is supplied with 1 GByte of double data-rate synchronous dynamic RAM (DDR SDRAM). This is a dual in-line memory module (DIMM) in a socket. You can upgrade your memory to 2 GBytes simply by exchanging the DIMM. See page 35 on how to open a Power1401, and see the diagram on page 37 for the location of the socket. The Power1401 automatically detects the size of the installed memory at power-on, so there is usually no need to alter any switches or software settings if the memory is upgraded.

Memory specification Any memory you obtain should meet the following specification:

- DDR-2 SDRAM in 240-pin DIMM
- Speed: 800 MHz CL5 or CL6
- Standard: PC2-6400

DIMM memory not meeting this specification will not work. The CED warranty on the Power1401-3A does not cover malfunctions caused by users attempting to upgrade their units.

Suitable 2 GByte memory DIMM The Kingston KVR800D2N6/2G is a 2 GByte, non-ECC DDR DIMM that will run in the Power1401-3A.

Self-test and the memory The standard, short self-test will take about 1 second. The long test, which tests the memory, takes about 1 minute per gigabyte. To run it, position 7 of the internal options switch must be set, i.e. in the Off position (see page 35.)

Testing 2 GByte DDR The long self-test must be run if you have fitted a 2 GByte DDR. If it fails, the DAC and ADC LEDs will flash on and off at about 1 Hz. In this case, set position 3 of the internal options switch On, to enable 2T mode, and re-run the long test. If the DDR still fails, then that particular part is not usable.

Electrostatic precautions When exchanging DIMMs, take precautions against static electricity. Earth the Power1401 case to mains earth, and yourself to the case, preferably via a wrist strap. Release the old DIMM by pushing the small ejection levers on either side of the socket. Ensure the new DIMM has no static charge by touching its conductive wrapping before handling it. Avoid touching metallic contacts on the DIMM: it is best to hold it by the short



edges. DIMMs are mechanically polarized: you cannot insert one upside down. Inserting the DIMM takes some force; the module is only truly inserted when the ejection levers snap shut.

Setting the ADC input range

The ADC and DACs may together be set to a working range of ± 5 V or ± 10 V. This is done through TRY1401 (version 3.35 or later). The setting is stored in non-volatile memory and is not affected by power cycling. Your Power1401 will be supplied with the default setting of ± 5 V unless you have asked for it to be supplied with the range set to ± 10 V.

Warning Note that analogue performance is inherently poorer on the ± 10 V range: ADC inter-channel cross-talk rises disproportionately faster with sampling rate, and DAC settling time is longer.

To alter the voltage range, select

Start, All Programs, 1401 support, TRY1401

Inside the *File* menu, click on *1401 Options...* Select from the dropdown list to set the ADC and DACs working range. Hit *OK* to confirm the change, or *Cancel*, as appropriate. The change takes effect the next time the Power1401 is power-cycled.

TRY1401, ADC and DAC range selection

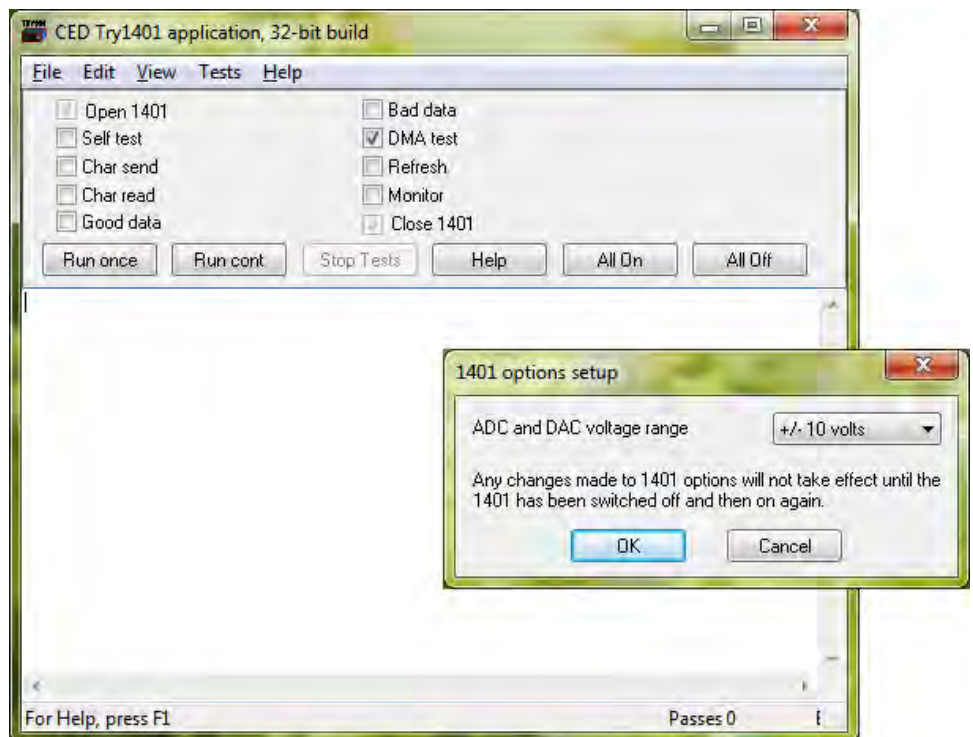

Flash ROM and the Power1401-3A Monitor

The Power1401 stores various software items in its non-volatile SPI flash ROM. The primary boot loader, the power-on self-test firmware, and the monitor (the operating firmware) are all stored in block 0. The FPGA configuration image is stored in block 1. Both blocks are automatically loaded on power-up, so long as the rear-panel Mode selector is in position 1. This tells the primary boot loader to load blocks 0 and 1.

Memory block overwrite warning

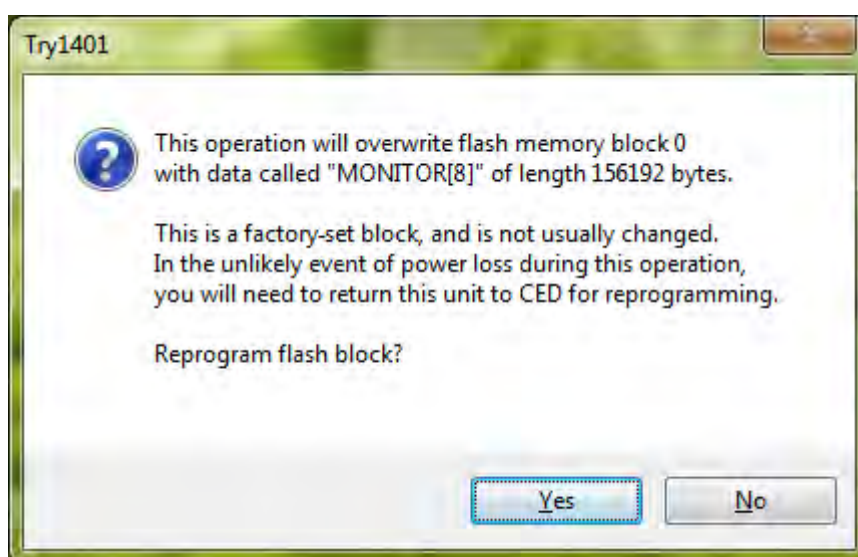

Upgrades and the Internet

Monitor and FPGA upgrades are available as .fli files from the *Downloads* page of CED's website, www.ced.co.uk. You will find detailed instructions there on downloading the files.

TRY1401 Monitor and FPGA upgrades are implemented by updating the SPI flash ROM using the TRY1401 utility. To open TRY1401, select

Start, All Programs, 1401 support, TRY1401

From *File* select *Update Flash*. The destination for the new monitor is set automatically to block 2, and the FPGA image to block 3, so the old monitor and FPGA images are still there in case of disaster, e.g. power failure during the few seconds taken writing the file. Blocks 0 and 1 are pre-loaded. If you do write to them you are warned first. To use the new monitor or FPGA image, set the rear-panel Mode selector to 2 and switch the Power1401 DC off and on again. Check that the Power1401 is operating correctly.

Analogue calibration The ADC & DAC Test option inside TRY1401 is provided to calibrate the ADC inputs. Before we ship your unit, we run this program and set the waveform system to an accuracy of approximately 0.5 mV, or three least significant bits (LSBs). On the ± 5 V range, one sixteen-bit LSB corresponds to only 150 μ V, which is of the same magnitude as the drift caused by the normal ageing of components. Therefore, if accurate voltage measurement is important to you, we suggest that you calibrate your Power1401 against a known standard as part of your experimental protocols, and check the absolute accuracy once every six months. We find that most units drift by substantially less than thirty-two LSBs (0.05%) over this period.

Equipment needed To make use of this program you will need two BNC-to-BNC cables, a BNC tee-junction, and an accurate digital voltmeter (DVM) having a resolution of 10 μ V on the ± 5 V range. It is most important that you allow the Power1401 to warm up, with power on for at least thirty minutes before you start the calibration, to allow the system to reach thermal equilibrium.

Alternatively, you may choose to return your Power1401 to CED for calibration. See page 45 for advice on sending it back.

Running TRY1401 To run TRY1401, select
Start, All Programs, 1401 support, TRY1401
ADC & DAC Test is an option inside *Tests*. The screen instructions detail the equipment required and the actions taken at each step. The procedure involves calibrating the DACs against the DVM, then calibrating the ADC against DAC0.

Electrostatic precautions When working inside the Power1401 take precautions against static electricity. The case is connected to mains earth via the power cable. Earth yourself to the case, preferably via a wrist strap.



Cleaning the Power1401 The Power1401 needs periodical cleaning to remain in good condition. Before cleaning, remove power and all cables from the Power1401.

The exteriors of the Power1401 case and the power supply should be cleaned annually to remove deposits of foreign matter, with a soft cloth moistened with a mild detergent solution. Avoid spilling drops of water or any other liquid on the Power1401. Note: this product is not designed to withstand aggressive or caustic cleansing products, nor is it proof against ingress of liquids.



Check the BNC connectors and rear-panel plugs and sockets for pieces of paper or fluff. If any are seen, remove them with a pin.



Check cables visually for fraying or other mechanical damage.

Trouble shooting

Overview The Power1401 has comprehensive built-in self-test capabilities which are backed up by a range of test and diagnostic programs to help pin-point problems quickly. If you suspect that you have a hardware fault, you should follow the procedures below to obtain as much information as you can about the problem, then call the CED Hardware Help Desk for advice.

Stand-alone test This is the simplest test of a Power1401. It eliminates the possibility of a host computer or cable fault confusing the situation. Disconnect the Power1401 from the host at the 1401 end of the USB cable, remove all signal connections and then apply power to the Power1401.

Power-on self-test The  indicator should switch on glowing red. The firmware first performs a short memory test, then tests the rest of the hardware. During this time, the ADC and DAC LEDs dance in characteristic patterns. If all is well, the  indicator then turns green. The yellow LEDs continue to flicker, only stopping when the Power1401 is reconnected to a working computer.

 indicator flashing red and green If the  indicator flashes red and green at the end of the power-up self-test, the Power1401 self-test firmware has detected a problem. It is likely that TRY1401 will be able to provide details of the problem. You will need to connect your Power1401 to the host computer before running the test. Open TRY1401 by selecting

Start, All Programs, 1401 support, TRY1401

Running TRY1401 Check the *Self test* box, then click on *Run once*. If no errors are detected it may be worth running continuous self-test (*Run cont*) to pick up any intermittent fault. Inform CED of any reported errors: *File, Send Mail* will create a new email with the report as an attachment (you can also copy and paste.) Our hardware help address is hardhelp@ced.co.uk.

LED diagnostic patterns The self-diagnostic firmware of the Power1401-3A can display a number of patterns on the front-panel BNC LEDs and the  indicator. These indicate normal running, the phases of self-test, and various error conditions.

What is seen In the table below, the yellow LEDs referred-to are the two DACs and the eight ADC inputs. The state of the six LEDs on the right is not relevant. Behaviour is as below:

- Bar graph: LEDs light progressively from left to right (memory write), then retreat (memory read)
- Test numbers: LEDs show the test number, LSB on the *left*
- Frozen pattern: LEDs halt on the number of the failed test
- Binary ramp: LEDs count up in binary, LSB on *left*
- Dancing DACs: the two leftmost LEDs toggle their original states at 1 Hz
- As per program / As before: LEDs continue doing whatever they were doing before

1401 status	Yellow LEDs	 Indicator
Normal running	As per program	Green
Memory test	Bar graph	Red
Memory test fail	All flashing	Red
Self-test	Test numbers	Red
Self-test fail	Frozen pattern	Flashing red/green
Self-test pass, cable out	Binary ramp	Green
Self-test pass, cable in	All off	Green
Total hardware failure	All on	Red
CPU crash	Dancing DACs	As before
Software error	As per program	Red
Over-temperature	All on	Off

**Calling the
CED Help Desk**

If you cannot diagnose your Power1401 problems yourself, do call our Hardware Help Desk. Please email if possible. Our email address is:

hardhelp@ced.co.uk

We also have a direct phone line to the Hardware Help Desk:

+44 (0)1223 433477

Otherwise, our phone and fax numbers are at the front of this manual. If your email has attached files, please ensure that they are less than 1 MByte (zipped). To save yourself time, and improve the efficiency of the process:

- Please find the serial number of your machine, printed on the back, in the form P 6xxx.
- If the problem is with a program, please make a note of the version number, announced on entry, or from *Help, About...*
- It is often useful for users to have run TRY1401, so that we know about the hardware state.

Sending it back

If you need to send the Power1401 back to CED:

- You must first get a returns number from CED.
- Ship by Federal Express, UPS, or DHL Worldwide. DO NOT use TNT or a freight-forwarding company.
- We advise you to dispatch the machine to us using a door-to-door express service, and CIF, not FOB. CED is not responsible for the safety of the equipment until it is inside our premises.
- If you are dispatching from outside the EU, it is essential to call us for advice on the documentation necessary to get your machine through Customs. If you do not provide the correct documentation it may be subject to additional taxes or duties, turned back, or even impounded.
- Include a paper description of the problem with the equipment.
- Make sure the packaging is adequate to avoid damage in transit: your package may be dropped several metres!

- #
- ⏻ button, 3
- ⏻ indicator
 - diagnostic, 43
 - flashing red and green, 3, 10, 14, 43
 - steadily green, 14
- 1**
- 1401 device no., 7, 8
- 1902 isolated pre-amplifier, 12
- 1-Wire port, 23
- 2**
- 2701-04, 16 ADCs with gain, 30
- 2701-05, 4 more DACs, &c, 31
- 2701-09, 6 Event BNCs, &c, 32
- 4**
- 4001-03, 16 ADC channels, 29
- 6**
- 6-month accuracy check, 41
- A**
- ADC
 - conversion rate, 15
 - description, 16
 - external convert, 15
 - input, 16
 - input range, 15, 29, 30, 31, 32, 39
 - internal triggering, 15
- Analogue calibration, 41
- Application software, 5
 - Signal, 13
 - Spike2, 12
- B**
- Battery operation, 28
- BNCs
 - ADC 0-7, 15
 - Clock 2, 20
 - DAC 0 & 1, 17
 - Digital Out 0 & 1, 23
 - Event 0 & 1, 20, 21, 22, 23
 - Trigger, 15
- C**
- Cables
 - fraying, 42
- Calibration of analogue system, 41
- CED's email address, 45
- CED's website, 5, 40
- Circuit diagrams, 5
- Cleaning, 42
- Clock E inputs, 22
- Clock F input, 20
- Clock inputs and output, 20
- Confidence check, 3
- Connections
 - ADC inputs, 15
 - Clock 2 output, 20, 21
 - DAC outputs, 17
 - DC power, 28
 - DC supply, 28
 - f.p. Digital I/O, 23
 - f.p. Event 0 & 1, 22
 - f.p. Trigger, 15, 17, 20
 - mating parts, 19, 22, 26
 - r.p. Analogue Expansion, 17, 18, 19, numbering, 18, 29, 30, 31, 32
 - r.p. Digital Inputs, 20, 25
 - r.p. Events, 22
 - ADC convert, 16
 - Clock E inputs, 22
 - Clock F, 17, 20
 - Event Out, 22
 - RS232 port, 27, 28
 - Synchronization port, 27
 - USB, 27
- Cooling fan, 4
- CPU crash LED pattern, 44
- Crystal oscillator, 20, 21
- D**
- DACs
 - external updating, 17
 - internal updating, 17
 - output range, 17, 39
- Data
 - non-repetitive, 12
 - repetitive, 13
- DDR 2T mode, 38
- DDR SDRAM, 38
 - specification, 38
- Device drivers, 6
- Diagnostic programs, 43
- Digital audio, 21
- Digital I/O
 - format, 23
 - fused +5V line, 24
 - handshakes, 24
- Digital input
 - change of state, 23
 - pull-ups, 25
- Digital output
 - external enable, 23
 - gated with Clock 2, 23
- Digital volt meter, 34, 41
- Drift in accuracy, 41

E

Electromagnetic interference, 4
Electrostatic discharge, 14, 38, 41
Environment for 1401, 4
Event inputs, 21
Evoked-response recording, 13
Expanded mechanics, 29, 30, 31, 32, 33
Expansion BNCs
 ADC 8-15, 31, 32
 ADC 8-23, 29, 30
 DAC 2 & 3, 32
 DACs 2-7, 31
 Digital Out 2 & 3, 31
 Events 2-7, 32
Expansion options
 16 ADC channels, 29
 16 ADC channels with gain, 30
 4 more DACs, &c, 31
 6 Event BNCs, &c, 32
External convert input, 15
External frequency source, 20

F

Fan, cooling, 4
Ferrite choke, 15, 17, 18, 21, 25
Fluff, 42
FPGA upgrades, 40
Frequency synthesizer, 21
Front-panel indicator LEDs, 14
 ADC inputs, 16
 Clock 2, 20
 DACs, 17
 diagnostic, 44
 Digital Out 0 & 1, 23
 Event 0 & 1, 20, 23
 Trigger, 16, 20

H

Hardware failure LED pattern, 44
Hardware faults, 43
Hardware installation
 USB interface, 6
Help Desk, hardware, 43, 45
Hot plugging, 6

I

Ingress of water or dust, 4
Inner can, 33
Input drive requirements
 ADC channels, 16
 f.p. Event 0 & 1, 21, 25
 f.p. Trigger, 16, 21
 r.p. ADC convert, 16
 r.p. Clock E & F, 22
 r.p. Digital Input, 25
Input hysteresis
 f.p. Event 0 & 1, 21
 f.p. Trigger, 16, 21
Input pulse widths, 16, 21, 22, 24, 25
Installation kit checklist, 2
Internal relay, 28

L

Lead-free, 14, 21, 22, 25
Life support, vi

M

Mains earth, 14, 28, 34
Mains isolation, 3, 14
Mains voltage, 3
Maintenance operations, 35, 42
Memory fail LED pattern, 44
Memory self-test, 38
Memory upgrades, 38
Mode selector, 3, 40
Monitor, 40
 upgrades, 40
MOSFET protection, 14, 16, 21, 22, 25

O

Options DIL switch, 35, 38
Outer case, 33
Output drive capability
 Clock 2, 21
 DACs, 18
 Event Out, 22
 f.p. Digital Out 0 & 1, 25
 r.p. Digital Output, 25
Over-temperature LED pattern, 4, 14, 44

P

Physiological recordings, 12
Power brick, 3, 6, 14, 28, 34, 49
Power-on self-test, 14, 35, 38, 40
Primary boot loader, 40
Programming manual, 5

R

Rack-mount hardware, 33
Rear-panel connector diagrams, 14
Rear-panel connector shells, 14
Recycling, 4
Running `setup.exe`, 9

S

Safe voltages
 Expansion Events 2-7, 32
 f.p. Event 0 & 1, 21
 f.p. Trigger, 16, 22
 f.p. Trigger, 21
 r.p. ADC convert, 16
 r.p. Clock E & F, 22
 waveform (ADC) inputs,
 16
Self-test capability, 43
Self-test fail LED pattern, 44
Sending Power1401 to CED,
 29, 30, 31, 32, 45
Signal, 5, 10, 31
Silicon serial numbers, 23
Sleep recording, 12
Software error LED pattern,
 44
Software installation for USB
 Vista, 6
 Windows 10, 6
 Windows 7, 6
 Windows 8, 6
 Windows XP, 6
Soldering, 21, 22, 25
Spike2, 5, 10, 32
Stand-alone test, 3, 43
Synchronization cable, 27
Synchronization port, 27
Synchronizing 1401s, 20

T

Taking the lid off, 35
Technical support manuals, 5
Tools
 1-pt Pozidriv, 35
 2mm hex wrench, 34, 35
TRY1401, 1, 10, 15, 29, 30,
 45
 ADC & DAC test, 11, 41
 Analogue calibration, 41
 Clocks & Events test, 11
 Monitor upgrades, 40
 Send email report, 43
 Waveform I/O voltage
 range, 39

U

USB data cable, v, 6, 27, 43
USB port, 27

W

Waveform input channels, 15
 gain, 15
Waveform output channels,
 17
Waveform system accuracy,
 41
Windows 10, 5
Windows 8, 5
Windows Device Manager, 7,
 8
Windows Vista, 5
Windows XP, 5

User notes

Specification

Waveform inputs	Input impedance	1	megohm
	Active working voltage range (software selectable)	± 5 or ± 10	volts
	Safe voltage range	± 15	volts
	Maximum conversion rate		
	single channel	2	megahertz
	multi-channel	1	megahertz
	Resolution	16	bits
	Crosstalk & noise	± 2	LSBs up to 200kHz/chan
Waveform outputs	Active working voltage range (software selectable)	± 5 or ± 10	volts
	Safe drive capability	600	ohms
	Full accuracy drive	5	kilohms
	Maximum update rate	500	kilohertz
	Resolution	16	bits
Front-panel digital inputs	Input impedance	100	kilohms to +5 V
	Safe voltage range	± 10	volts
	Shortest pulse-width	1	microsecond
	Low voltage	0.8	volts
Clocks	Accuracy & drift, 0-70°C	50	parts per million
Rear-panel digital and event inputs	Input impedance	4.7	kilohms minimum
	Safe voltage range	± 10	volts
	Shortest pulse-width	100	nanoseconds
	Low voltage	0.8	volts
	Low current	1.5	milliamps maximum
Digital outputs	Drive capability	± 20	milliamps
Mains Supply	Voltage range	100 to 240	volts
	Frequency range	47 to 63	hertz
	Current	0.8	amps
Case size & weight	Power1401-3A	88 × 219 × 428	millimetres
		3.0	kilograms
	Power brick	40 × 75 × 130	millimetres
		0.45	kilograms
Environment	Temperature range	-5 to +50	°Celsius
	Maximum humidity	95%	non-condensing



EC Declaration of Conformity

This is to certify that the:

CED Power1401-3A

Manufactured by:

Cambridge Electronic Design Limited
Science Park, Milton Road, Cambridge CB4 0FE, UK
Tel +44 (0)1223 420186

Conforms with the protection requirements of Council Directive 2004/108/EC,
relating to Electromagnetic Compatibility,
by the application of the following harmonized EMC standard:

EN61326-1 (2006) Class B - COMPLIES

FCC CFR47 Part 15 Subpart B Class A - COMPLIES

Signature

A handwritten signature in black ink that reads "Peter Rice". The signature is written in a cursive style and is underlined.

Peter Rice
Technical Director

Date

12 September 2012